

Fundamentals for North American Market Access

Alessio Dellanoce



EU Safety System

EU

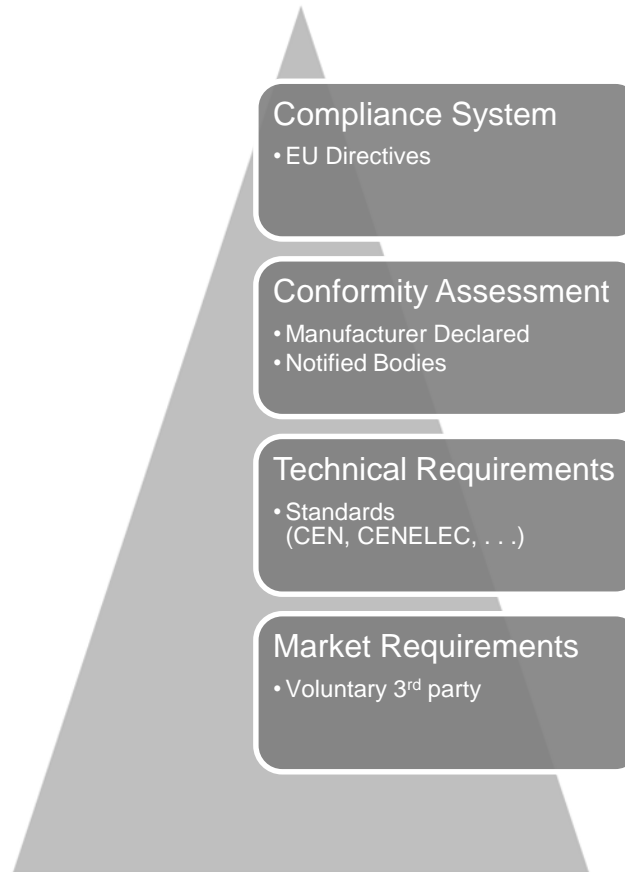

Conformity Assessment Defined

“any activity concerned with determining directly or indirectly that relevant requirements are fulfilled”

ISO/IEC Guide 2



Conformity Assessment Demand Drivers

Government (Market Access)

- through regulation
- at the federal, state, and local levels
- *reflects societal needs*

Market (Market Acceptance)

- demand from consumers, retailers, distributors, insurers, commercial purchasers...
- *reflects the needs of the market*

US Model: A Public-Private Partnership

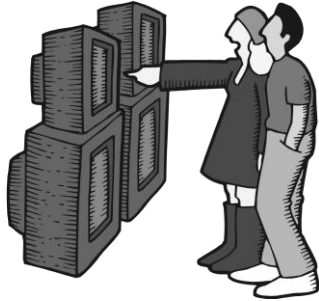

Retailers/Distributors

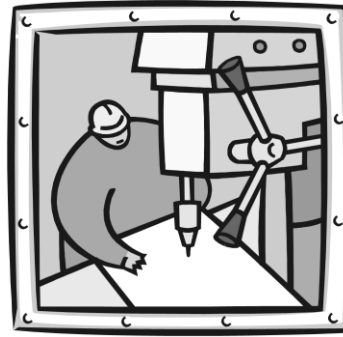

Manufacturers

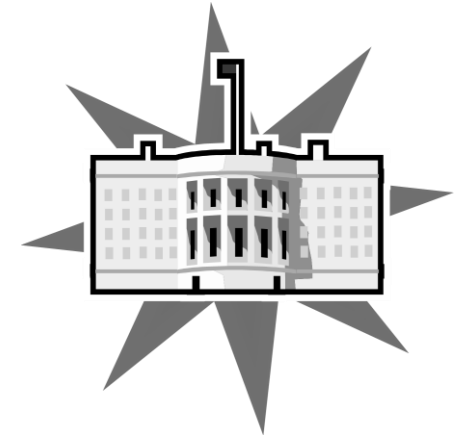

Government,
Regulatory Agencies



Consumers

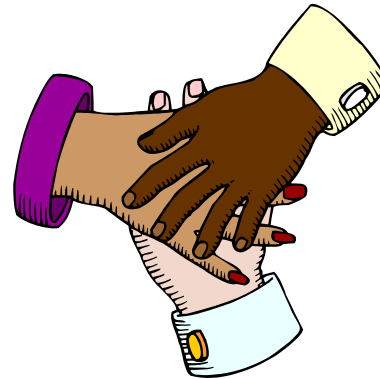

Standards and Certification Organizations

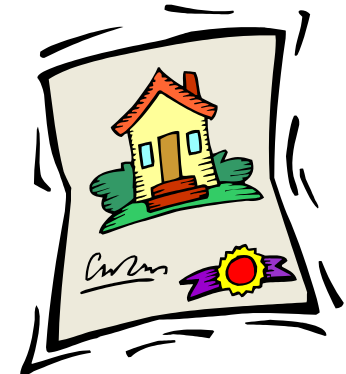

Insurance
Providers



The US Approach to Conformity Assessment

Consensus Standards

Industry
Consumers
Authorities
Certifiers
Interested Parties

Threshold of
Safety

Pre-market Assessment and Certification

Verification of
Conformity to the
Standard
Factory Pre-
Inspection &
Approval

Ensuring Safety
Entering the
Market

Ongoing Factory Surveillance

Verification That
Product “As Built”
Conforms to the
Approval

Avoid
Adulteration

Post Market Surveillance

Random Purchase
at Retail and
Verification Testing
Anti-Counterfeiting
Communications
with CPSC

Monitor Real-Life
Outcomes

Recipe for maintaining “Integrity & Trust” and balancing “Safety & Time-to-Market.”



Federal Regulatory System: Market Acceptance



Federal
Communications
Commission
(FCC)



Occupational
Safety and
Health
Administration
(OSHA)



Consumer
Product Safety
Commission
(CPSC)



Food and Drug
Administration
(FDA)

Several federal agencies mandate product conformity and
accredit private sector providers.

USA

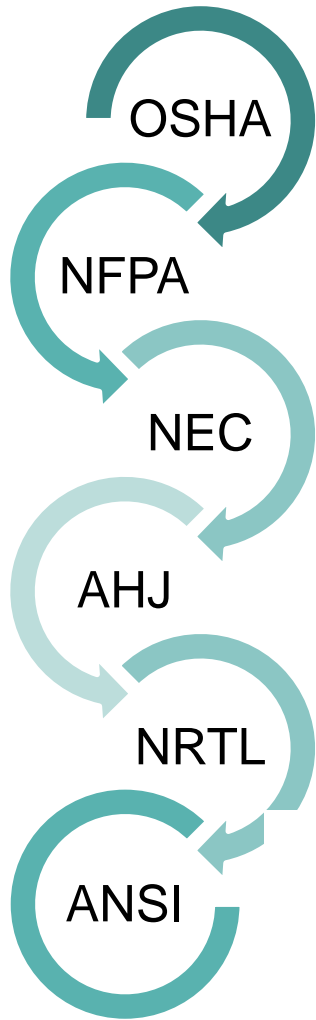

Occupational Safety and Health Administration

Ente che pubblica le linee guida per la sicurezza degli stabilimenti e dei luoghi di lavoro (officine meccaniche, laboratori).
Compie visite ispettive annuali nelle sedi NRTL (anche nella affiliate come UL Italia).

Web site: www.osha.gov



National Fire Protection Association

NFPA è l'ente riconosciuto dal governo americano in merito alle installazioni.

La "missione" di questa organizzazione internazionale senza scopo di lucro, è quella di ridurre il pericolo del fuoco nella vita quotidiana.

La NFPA70 (nota anche come NEC – National Electrical Code) è il codice di installazione elettrica americano utilizzato dagli ispettorati locali (AHJ) per la valutazione delle installazioni delle apparecchiature ed impianti elettrici.

Web site: www.nfpa.org



Authority Having Jurisdiction

Organismi locali non collegati tra loro (differenti per stato, contea, città...), preposti dal governo federale, avente come scopo quello di verificare che le installazioni elettriche siano conformi al NEC.



Le AHJ's hanno l'autorità di "Giudicare l'accettabilità" di un prodotto nella sua installazione in loco, poiché hanno la Responsabilità legale della non pericolosità dell'impianto finale.



Nationally Recognized Testing Laboratories

American National Standard Institute

E' il principale ente normatore degli USA che emette prescrizioni e norme (standard) in quasi tutti i campi, non solo elettrotecnico.

Per quanto concerne le apparecchiature in **bassa tensione** l'ANSI ha recepito ampiamente le prescrizioni NFPA ed UL (ad esempio il NEC, UL 508, ecc..).

Web site: www.ansi.org



The NRTL Program and Benefits of Relying on Private Sector Organizations

OSHA's Nationally Recognized Testing Laboratory (NRTL) Program recognizes private sector organizations as NRTLs to determine that specific products meet consensus-based safety standards to provide the assurance that these products are safe for use in the US workplace.

How does OSHA benefit from reliance on private sector NRTLs?

- Recognition Process that Preserves Confidence
- Reduces Government Costs
- Lessens OSHA's Market Surveillance Burdens
- Positively Affects the Development of Standards
- Promotes International Trade



Case: Impact of Third Party Testing Requirements on Toy Recalls in the US

The Consumer Product Safety Improvement Act (CPSIA) of 2008 introduced new third-party testing requirements for toys and children's products, and that the testing be conducted by an accredited CPSC-recognized third party lab and that the domestic manufacturer or importer issue a Certificate of that compliance.

What has been the result since CPSIA's enactment?

- 448 toy recalls in fiscal year (FY) 2007
- 172 toy recalls in FY 2008
- 50 toy recalls in FY 2009
- 46 toy recalls in FY 2010
- 34 toy recalls in FY 2011

USA

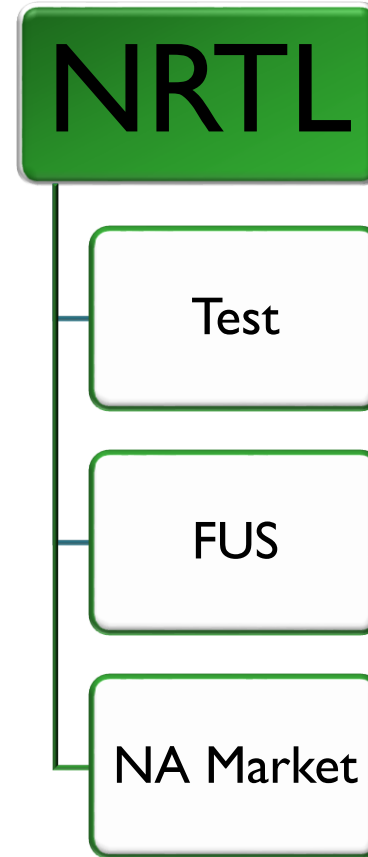
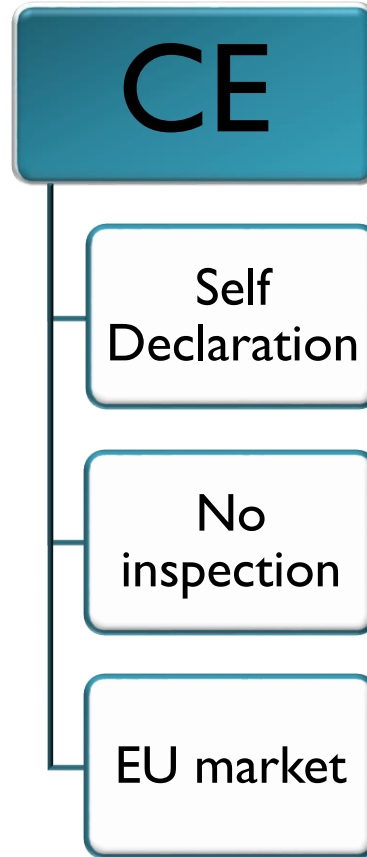
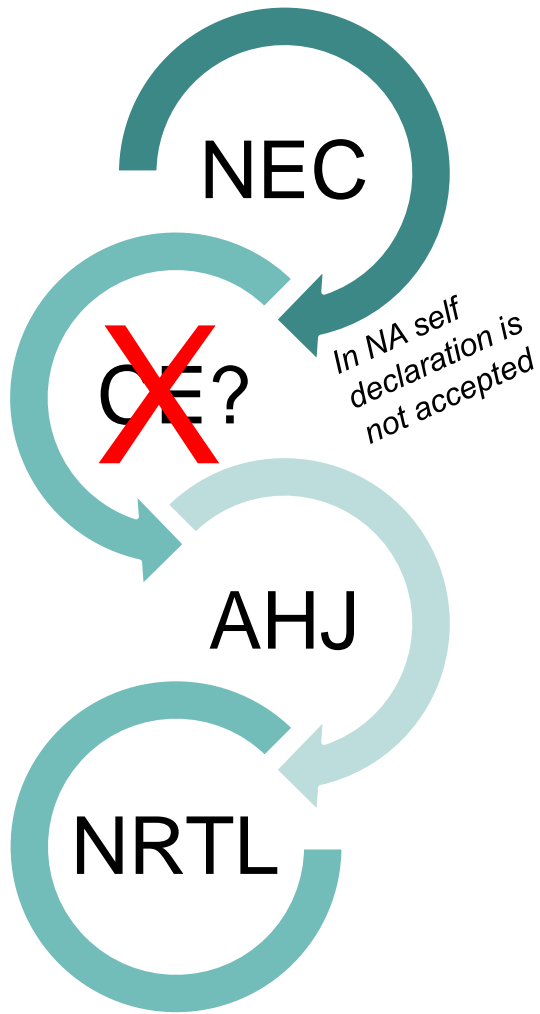

Compliance systems US vs EU

US

Compliance System

- US Product Liability Laws

Conformity Assessment

- AHJs
- NRTLs

Technical Requirements

- Standards (ANSI, UL, . . .)

Market Requirements

- Voluntary 3rd party

EU

Compliance System

- EU Directives

Conformity Assessment

- Manufacturer Declared
- Notified Bodies

Technical Requirements

- Standards (CEN, CENELEC, . . .)

Market Requirements

- Voluntary 3rd party

IFIA study conclusion 2102-2016

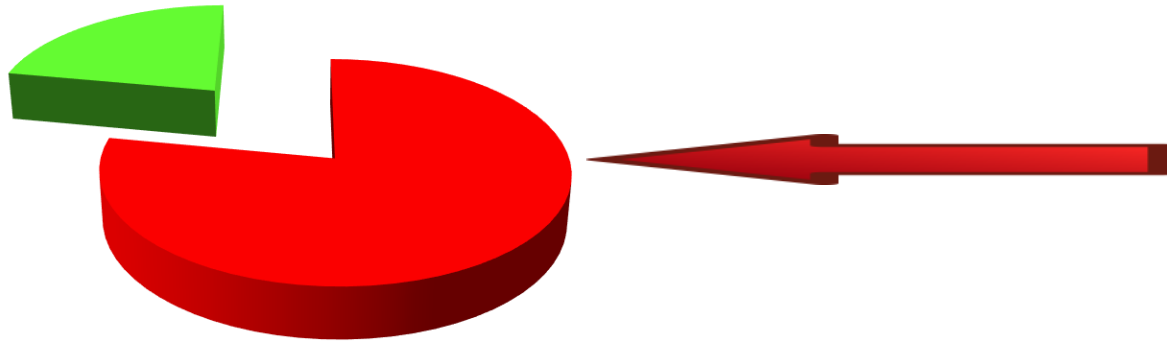

Of the 414 samples submitted, **73%** were **NOT** in compliance with EU standards and regulations

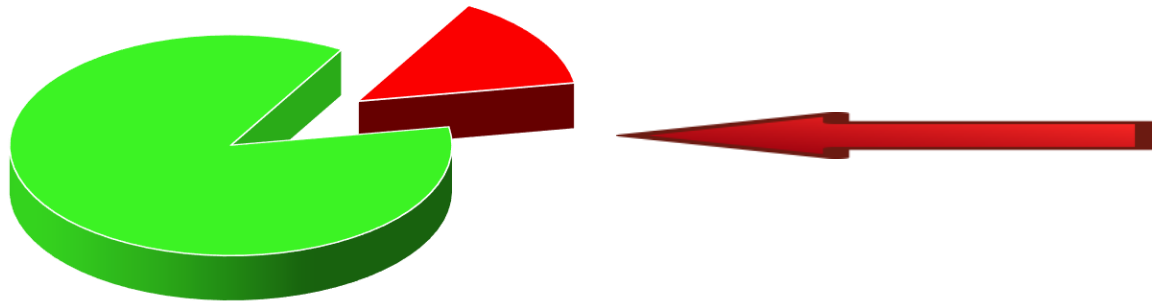

There were **68 instances (16%)** of *safety-critical* failures (i.e. high risk of **fire**, **permanent injury**, etc) which were/are being reported to the local authorities (1 every 6 products)





Thank you

Visit us on [UL.COM](https://www.ul.com)